



Panasonic

Panasonic

EHF-1BG0920

ભાગ નંબર:	EHF-1BG0920
ઉત્પાદક / બ્રાન્ડ:	Panasonic
ઉત્પાદન વર્ણન	BALUN 880MHZ-960MHZ 50/200 1206
માહિતી પત્ર:	 EHF-1BG0920.pdf
RoHS સ્થિતિ	 લીડ ફ્રી / આરઓએચએસ સુસંગત
સ્ટોક સ્થિતિ	7063 pcs stock
શિપ	ડોંગ ઢોંગ
શિપમેન્ટ વે	DHL/Fedex/TNT/UPS/EMS

અવનરણ માટે વિનંતી

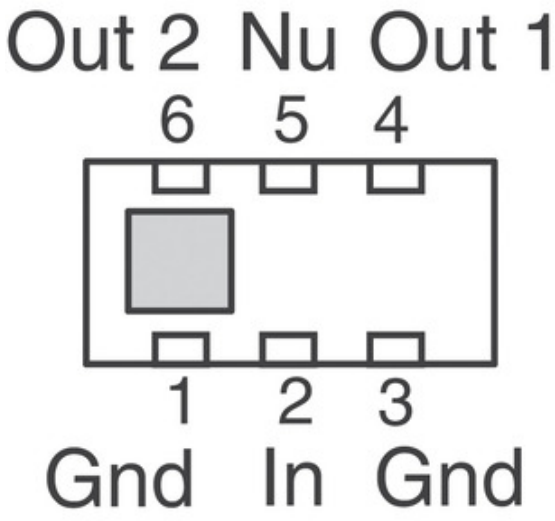

છબી સ્ક્રીનશોટ ડાઉન લોડ કરો. ઉત્પાદન વિગતો માટે વિશિષ્ટતાઓ જુઓ.











EHF-1BG0920 ની વિશિષ્ટતાઓ

ભાગ નંબર	EHF-1BG0920
ઉત્પાદક	Panasonic
વર્ણન	BALUN 880MHZ-960MHZ 50/200 1206
લીડ ફ્રી સ્ટ્રેસ / રોએચએસ સ્ટ્રેસ	લીડ ફ્રી / આરઓએચએસ સુસંગત
જથ્થો ઉપલબ્ધ છે	7063 pcs
ડેટા શીટ	 EHF-1BG0920.pdf
સિરીઝ	EHF
વળતર નુદશાન (લઘુ)	-
તબક્કો તકાવત	180° ±10°
પેકેજિંગ	Cut Tape (CT)
પેકેજ / ઢેસ	1206 (3216 Metric)
બીજા નામો	P12027CT
માઉન્ટિંગ પ્રકાર	Surface Mount
ભેજ સંવેદનશીલતા સ્તર (એમએસએલ)	1 (Unlimited)
લીડ ફ્રી સ્ટ્રેસ / આરઓએચએસ સ્થિતિ	Lead free / RoHS Compliant
નિવેશ નુદશાન (મેટ્રિક)	0.8dB
અસમર્થતા - અસંતુલિત / સંતુલિત	50 / 200 Ohm
આવર્તન રેન્જ	880MHz ~ 960MHz
વિગતવાર વર્ણન	RF Balun 880MHz ~ 960MHz 50 / 200 Ohm 1206 (3216 Metric)

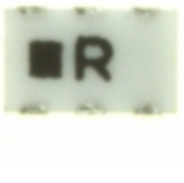
સંબંધિત ઝસ

Panasonic EHF-1BG0920	EHF-1BG0920 ડિસ્ક્રીબ્યુટર	EHF-1BG0920 પુરવઠોદર્તા
EHF-1BG0920 ભાવ	EHF-1BG0920 ચિત્રો	EHF-1BG0920 છબી
EHF-1BG0920 પીડીએફ ડેટાશીટ	EHF-1BG0920 ડેટાશીટ ડાઉનલોડ કરો	EHF-1BG0920 ડેટાશીટ
EHF-1BG0920 સ્ટોક	EHF-1BG0920 અરીદો	Panasonic EHF-1BG0920 અરીદો
Panasonic EHF-1BG0920	Panasonic સપ્લાયર	Panasonic ડિસ્ક્રીબ્યુટર
Panasonic EHF-1BG0920	Panasonic - Consumer Division EHF-1BG0920	Panasonic - Consumer Electronics Corp. EHF-1BG0920
Panasonic Battery Group EHF-1BG0920	Panasonic Electric Works - ACSD EHF-1BG0920	Panasonic Electronic Components - Semiconductor Pr EHF-1BG0920
Panasonic - ATG EHF-1BG0920	Panasonic - BSG EHF-1BG0920	Panasonic - DTG EHF-1BG0920
Panasonic Electric Works EHF-1BG0920	Panasonic Electronic Components EHF-1BG0920	Panasonic Industrial Automation Sales EHF-1BG0920
Panasonic Semiconductor EHF-1BG0920		

સંબંધિત વસ્તુઓ

 <p>EHF-140-01-F-D-SM ઉત્પાદકો: Samtec, Inc. વર્ણન: .050 EJECTOR HEADER ASSEMBLY ઉપલબ્ધ છે: 9552 pcs</p> <p>RFQ</p>	 <p>EHF-125-01-SM-D ઉત્પાદકો: Samtec, Inc. વર્ણન: .050 EJECTOR HEADER ASSEMBLY ઉપલબ્ધ છે: 8226 pcs</p> <p>RFQ</p>
 <p>EHF-2BD2450 ઉત્પાદકો: Panasonic વર્ણન: BALUN 2.4GHZ-2.5GHZ 50/50 0805 ઉપલબ્ધ છે: 3902 pcs</p> <p>RFQ</p>	 <p>EHF-1BD1800 ઉત્પાદકો: Panasonic વર્ણન: BALUN 1.7GHZ-1.9GHZ 50/50 1206 ઉપલબ્ધ છે: 4822 pcs</p> <p>RFQ</p>
 <p>EHF-2BE1800 ઉત્પાદકો: Panasonic વર્ણન: BALUN 1.7GHZ-1.9GHZ 50/100 0805 ઉપલબ્ધ છે: 3338 pcs</p> <p>RFQ</p>	 <p>EHF-2BD2060 ઉત્પાદકો: Panasonic વર્ણન: BALUN 1.92GHZ-2.17GHZ 50/50 0805 ઉપલબ્ધ છે: 6622 pcs</p> <p>RFQ</p>
 <p>EHF-1BE1800 ઉત્પાદકો: Panasonic વર્ણન: BALUN 1.7GHZ-1.9GHZ 50/100 1206 ઉપલબ્ધ છે: 3936 pcs</p> <p>RFQ</p>	 <p>EHF-1BG1800 ઉત્પાદકો: Panasonic વર્ણન: BALUN 1.7GHZ-1.9GHZ 50/200 1206 ઉપલબ્ધ છે: 5641 pcs</p> <p>RFQ</p>
 <p>EHF-125-01-SM-D-RA ઉત્પાદકો: Samtec, Inc. વર્ણન: .050 EJECTOR HEADER ASSEMBLY ઉપલબ્ધ છે: 6842 pcs</p> <p>RFQ</p>	 <p>EHF-125-01-SM-D-SM-LC ઉત્પાદકો: Samtec, Inc. વર્ણન: .050 EJECTOR HEADER ASSEMBLY ઉપલબ્ધ છે: 8216 pcs</p> <p>RFQ</p>
 <p>EHF-2BE0920 ઉત્પાદકો: Panasonic વર્ણન: BALUN 880MHZ-960MHZ 50/100 0805 ઉપલબ્ધ છે: 2806 pcs</p> <p>RFQ</p>	 <p>EHF-2BD1800 ઉત્પાદકો: Panasonic વર્ણન: BALUN 1.7GHZ-1.9GHZ 50/50 0805 ઉપલબ્ધ છે: 4044 pcs</p> <p>RFQ</p>

હોપિરાઇટ © 2020 ઇન્ફિનિટી ઇલેક્ટ્રોનિક્સ ઇન્ડિયા પ્રાઇવેટ લિમિટેડ

ઇ-મેઇલ: Info@infinity-electronic.com

સરનામું: 17 એક, ગેલોડ ઈન્ડિયા પ્રાઇવેટ લિમિટેડ, 114-118 લોડલાઇટ રોડ, વાન યાઇ, ડોંગઢોંગ

